

BRISTAN

Installation Instructions & User Guide

Please leave these instructions
with the end user

CAS HAND04 C (D1)

Specifications

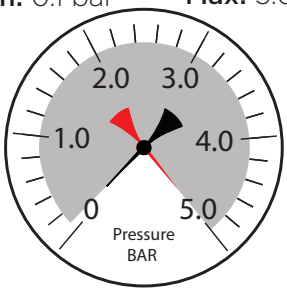
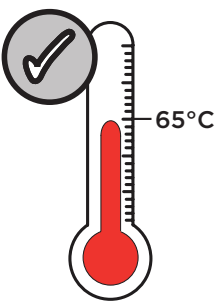
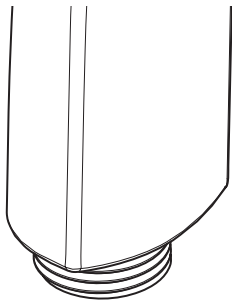
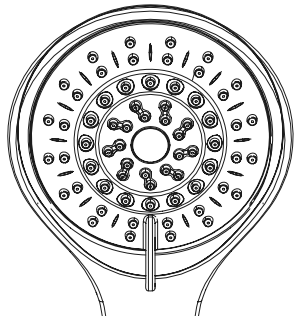
<p>Dynamic Water Pressure Min: 0.1 bar Max: 5.0 bar</p>  <p>Maximum Static Pressure: 10.0 bar</p>	<p>Inlet Water Temperature</p>  <p>Maximum Hot 65°C</p>	<p>Inlet Connections</p>  <p>1/2" BSP</p>	<p>Output</p>  <p>5 Function Handset with Rub Clean Nozzles</p>
--	---	--	---

Pack Contents

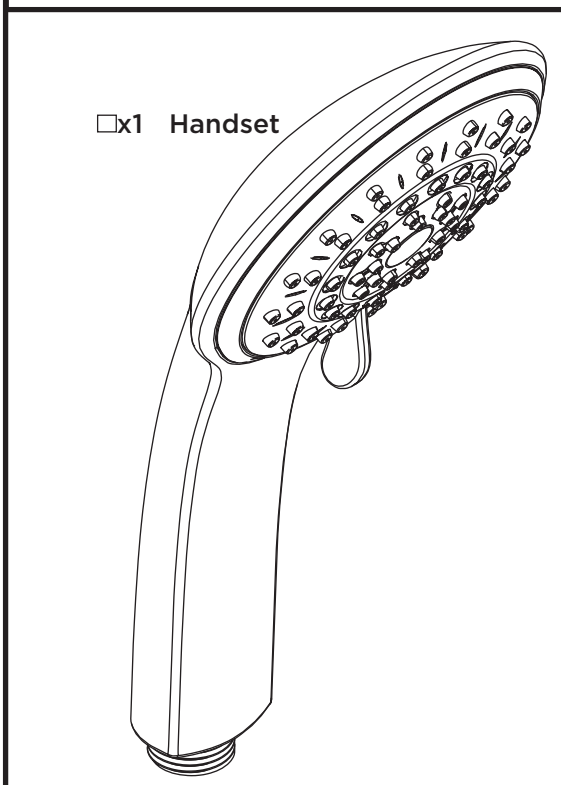

Dimensions (mm)

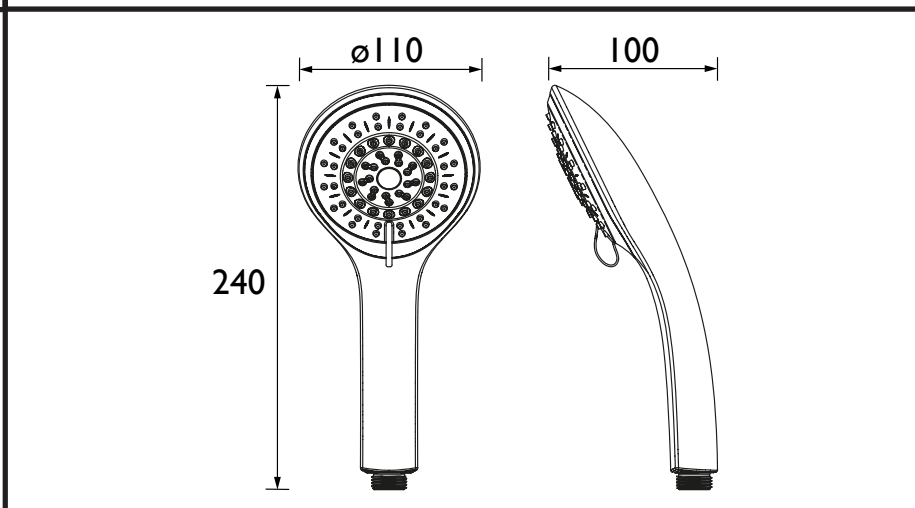

Tools Required for Installation/ Maintenance



O Ring Pick Tool

Prior to Installation

All products manufactured and supplied by Bristan are safe to use provided that they are installed, operated and receive regular maintenance in accordance with these instructions.

This product needs to be installed in accordance with, and meet the requirements of The Water Supply (Water Fittings) Regulations (Northern Ireland) 2009 and The Water Supply (Water Fittings) (Scotland) Byelaws 2014. For full Installation Requirements & Notes (IRN) please visit www.wrasapprovals.co.uk/approvals-directory

Before installing this product the water supply must be thoroughly flushed in order to remove any swarf, solder etc. Full access must be made available for future maintenance/servicing purposes.

This product must not be modified in any way as this will invalidate the guarantee.

Spare Parts



To replace any spare parts for your tap, why not scan the QR Code or visit www.bristan.com and search for your product.



Important

The images shown are for illustrative purposes only.

The handset you have purchased may look different to those pictured in this booklet but will follow the same installation steps.

Your contents page will be specific to your product.

If you find your product or any of its components differ from those shown on the contents page, please contact our customer support.

1*



IMPORTANT

Your handset may come with a flow limiter which will either be included pre-fitted or loose in the box.

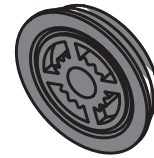
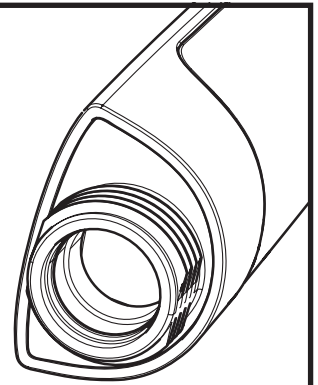

Check your contents page for more details. If a flow limiter is not supplied, go to Step 2.

1a

Firmly push the flow regulator into the threaded end of the handset, smaller diameter first.

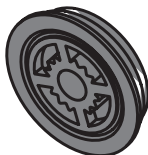
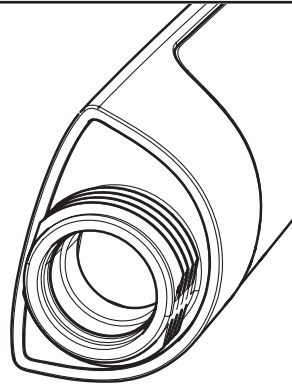

***If flow regulator is loose in the box**

1b

Use a small o'ring pick tool or similar tool to remove the flow regulator from your handset if required.

***If flow regulator is pre-fitted and not required**

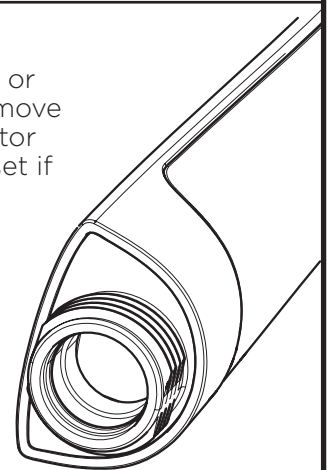
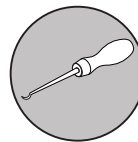

2

If a sealing/filter washer is supplied with your handset, ensure it is fixed in place before connecting.

Secure the cone end of the hose (not supplied) onto the threaded inlet connection of the handset. If washers are supplied with your hose, also make sure to fit these when connecting the handset.

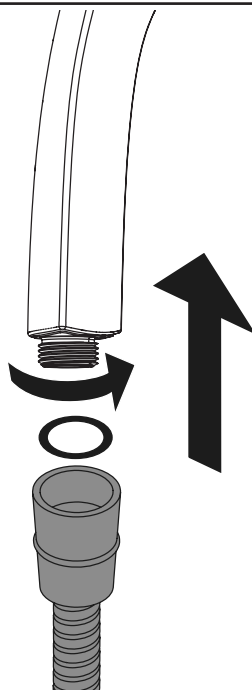

3



IMPORTANT

Turn on water supply for a few minutes and check all joints and connections for any leaks.

Your handset is now ready to use.

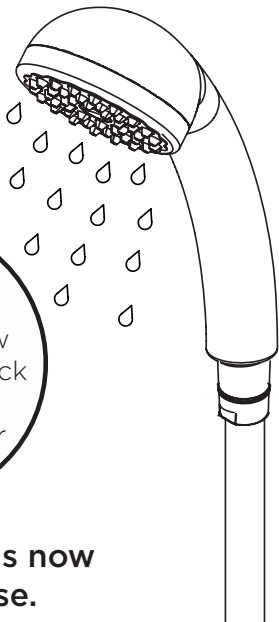

Operation - Multi-Function Handsets (3 & 5 functions)

1

Rotate Function

Rotate the spray head left or right for a different spray pattern.

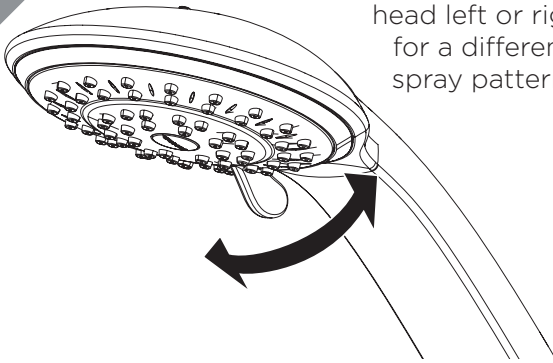

2

Push Button Function

Push the button up or down for a different spray pattern.

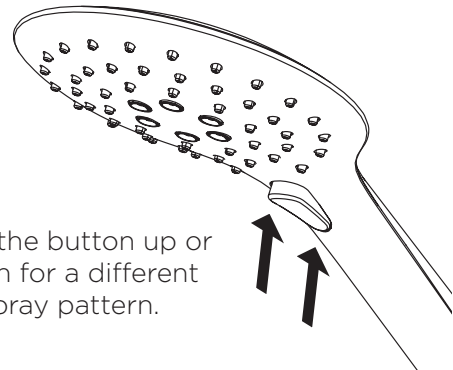

Maintenance - General Cleaning

Bristan products are made from premium materials, with hand polished, PVD, EPD or electroplated finishes. Your product should be regularly cleaned with warm water, a mild pH-neutral liquid soap, and polished with a soft cloth. Any residues from soap, toothpaste, shampoos and shower gels can cause blemishes if not rinsed off straight after use.

Household bleaches and cleaners contain harsh chemicals and may damage the surface finish. Avoid using abrasive cloths, scouring pads, scrub sponges, steel wool or anything similar.

Maintenance - Cleaning The Shower Head

Your Bristan shower head may have rub-clean nozzles for easy cleaning. See your contents page for more details. Simply rub your fingers across the rubber spray jets regularly and before you turn the shower on to remove and scale or debris.

The hardness of the water in your area will determine how often you should clean your shower head. Build up of scale in particularly hard water areas combined with constant use means you may need to clean your shower head weekly. To ensure continued performance, the shower head needs to be regularly de-scaled.

Need a Flow Limiter?

Do you need to limit the flow of your shower, but don't have a flow limiter on your shower or handset?

Try one of our ECO SHW limiters - simply attach between the hose and handset to limit the shower.

Scan the QR code or visit www.bristan.com and search for 'ECO SHW' to see the range.



Issue: D1

Part Number: FI Handset

BRISTAN

Bristan Group Ltd.

UK: Bristan Group, B78 1SG.

EU: Masco Europe S.à.r.l.
14 Rue Strachen
6933 Mensdorf
Luxembourg

Customer Service: +44330 026 6273

Web: www.bristan.com

Email: enquire@bristan.com

A Masco Company

At Bristan, we want to make things as easy as possible for our customers. That's why we offer solid guarantees on all our products, effective from the date of purchase, to give you peace of mind.

To start your free guarantee simply scan the QR code and register your product.
Alternatively visit www.bristan.com/register.

For any other queries, please call our Customer Service on **0330 026 6273** where our expert team of advisors will be able to offer you any help and advice.

For full guarantee terms and conditions visit www.bristan.com/service-centre/guarantees.

