

BRISTAN

Installation Instructions & User Guide

Please leave these instructions with the end user

Appeal Bath Shower Mixer Range | APL BSM (D1)

Specifications

Dynamic Water Pressure

Min: 0.3 bar Max: 5.0 bar



Maximum Static Pressure: 10.0 bar

Inlet Water Temperature

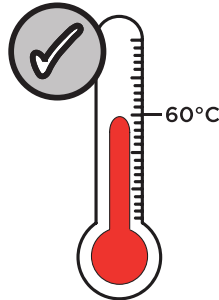

Maximum Hot 60°C

Inlet Connections

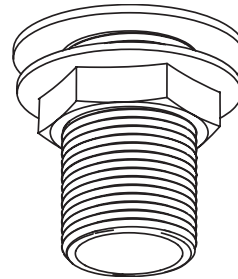

3/4" BSP

Outlet

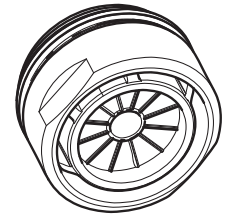

Housed M24 Flow Straightener

Pack Contents

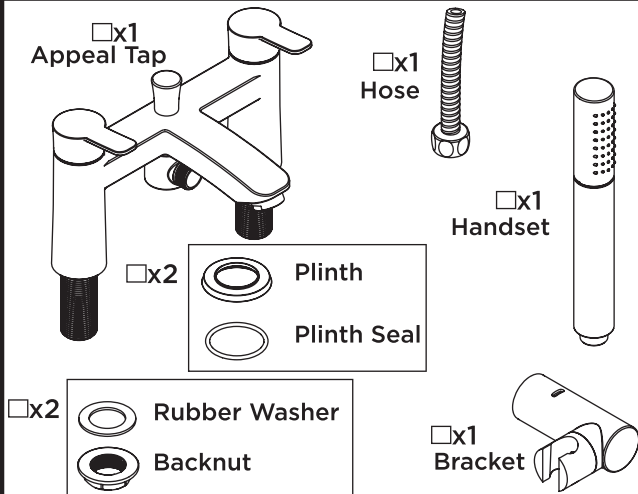

Operation

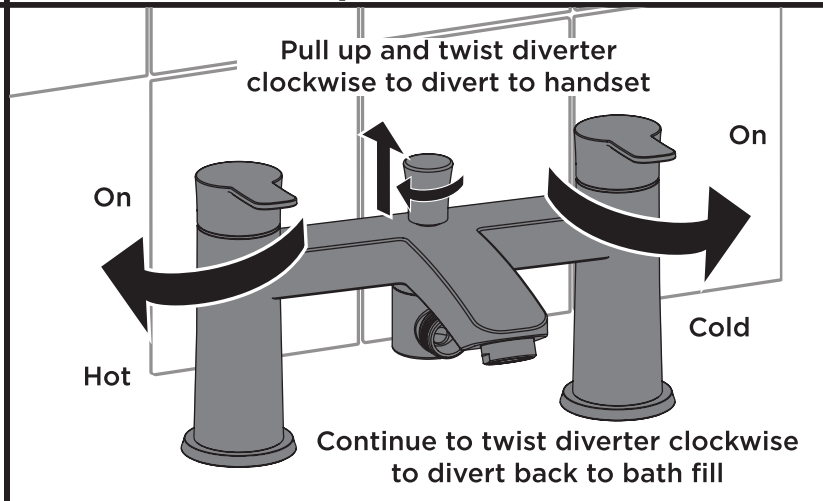

Tools Required for Installation/ Maintenance



Drill



Safety Glasses

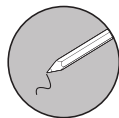

Pencil



Adjustable Spanner



Hexagonal Key (Grub Screws)

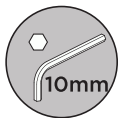

Hexagonal Key (Diverter)

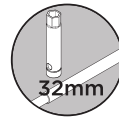

Box Spanner (Inlets)

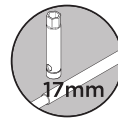

Box Spanner (Cartridge)



Phillips Head Screwdriver

Prior to Installation

All products manufactured and supplied by Bristan are safe to use provided that they are installed, operated and receive regular maintenance in accordance with these instructions.

This product needs to be installed in accordance with, and meet the requirements of The Water Supply (Water Fittings) Regulations (Northern Ireland) 2009 and The Water Supply (Water Fittings) (Scotland) Byelaws 2014. For full Installation Requirements & Notes (IRN) please visit www.wrasapprovals.co.uk/approvals-directory

Isolation valves must be fitted to the inlet water supplies to ensure ease of future maintenance.

Before installing this product the water supply must be thoroughly flushed in order to remove any swarf, solder etc. Full access must be made available for future maintenance/servicing purposes.

This product must not be modified in any way as this will invalidate the guarantee.

Spare Parts



To replace any spare parts for your tap, why not scan the QR Code or visit www.bristan.com and search for your product.

Installation - Wall Bracket

1

Pry off the bracket lid to reveal the screw holes

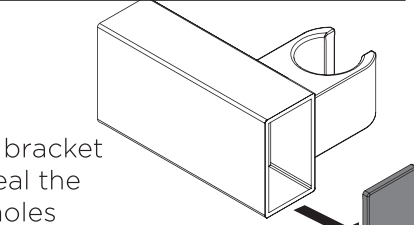

Observe screw holes inside of the bracket

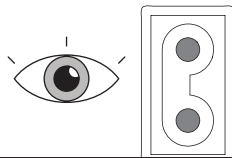

2

Position the wall bracket where you want it and mark out where to drill. Make sure the hose and handset can reach.

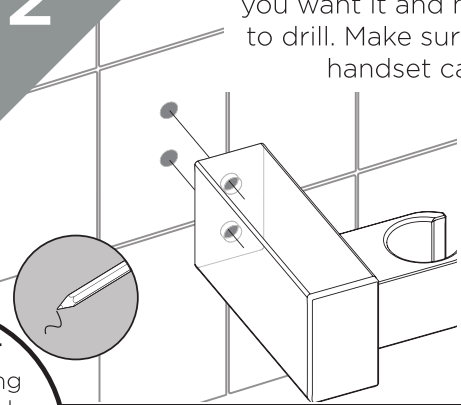

On most models, the screw holes are large enough to fit a pencil through for easy marking.

3

Drill hole(s) and fit wall plug(s) and then secure wall bracket to wall using screw(s) provided.

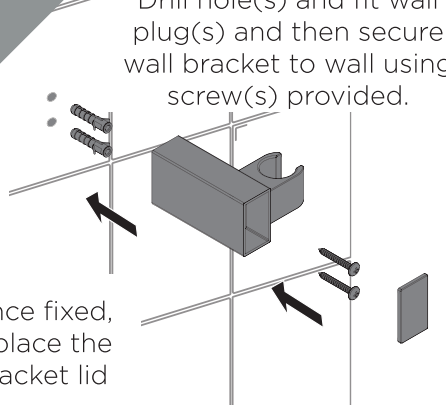

Once fixed, replace the bracket lid

4

Your bracket is now ready to use

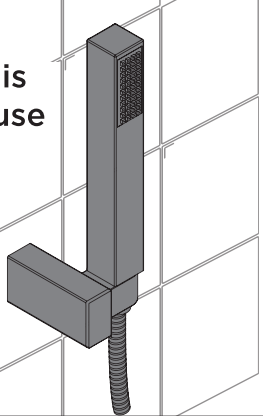

Check handset sits securely on the wall bracket and there is no movement

IMPORTANT

Prior to drilling into walls, check there are no hidden electrical wires, cables or water supply pipes

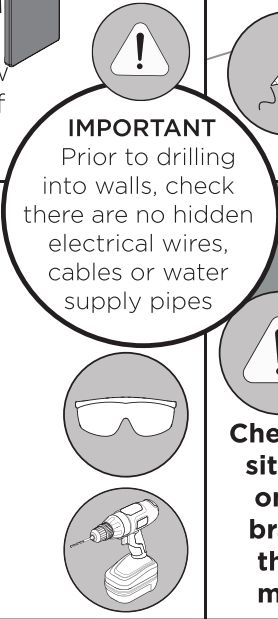

Maintenance - Diverter Replacement

1

Unscrew the hose from the elbow connection.

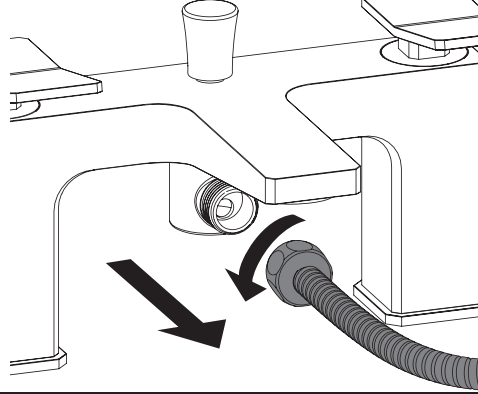

2

Unscrew the diverter head and lift off. Remove grub screw with hex key.

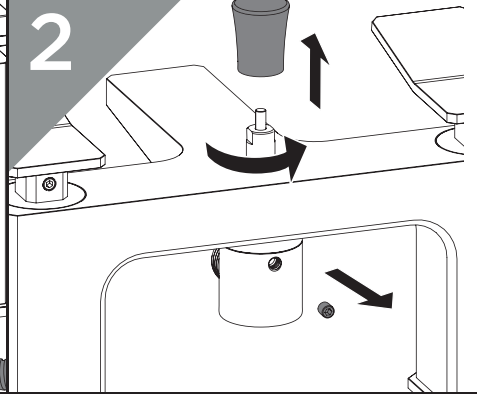

2.5mm

3

Pull elbow connection downwards to remove.

Remove the plastic insert.

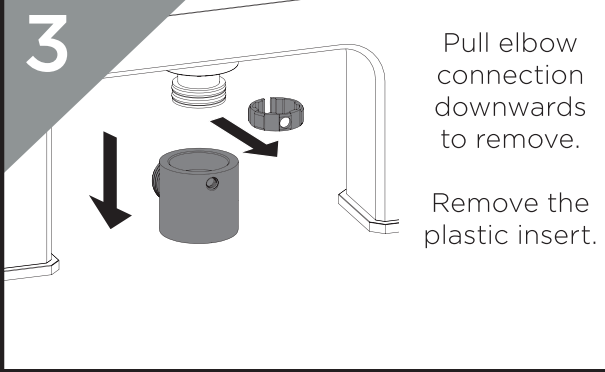

4

Insert hex key into bottom of diverter and unscrew.

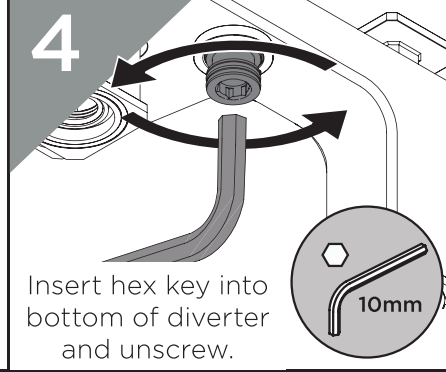

10mm

5

Remove the diverter.



6

Check diverter and O-rings for any damage, then soak using a suitable solution to de-scale.

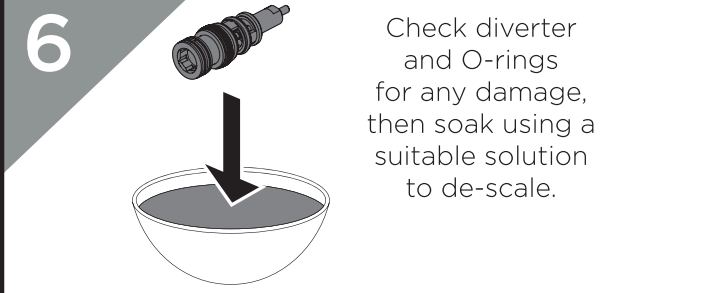

7

Reverse the steps to replace the diverter. Ensure the plastic insert Step 3 is correctly aligned when replacing.

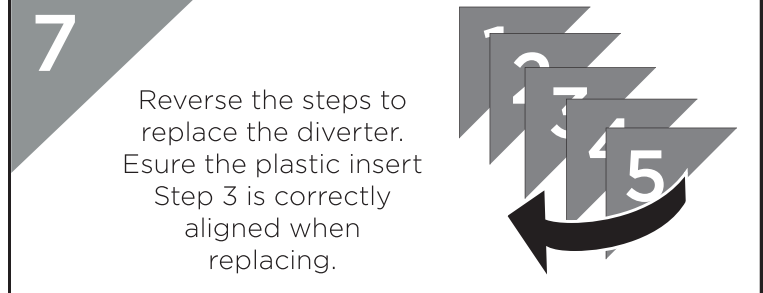



Important

The images shown are for illustrative purposes only.

The tap you have purchased may look different to those pictured in this booklet but will follow the same installation steps.

Your contents page will be specific to your product.

If you find your product or any of its components differ from those shown on the contents page, please contact our customer support.

Installation

1

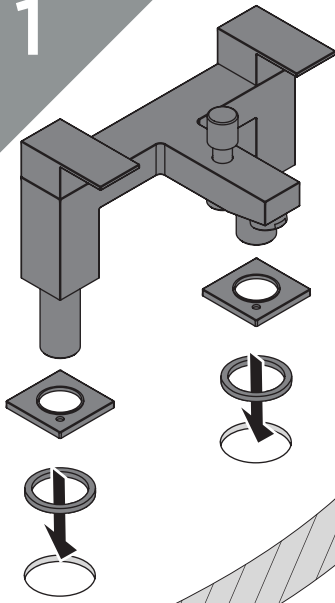

Feed the tap body through the plinths and ensure rubber plinth seals are in place

Once aligned, feed the threaded tails through tap holes

IMPORTANT
Your model may come with a plinth and will either be included pre-attached or loose in the box*

5

Secure the cone end of the hose onto the threaded inlet connection of the handset

If your model has one, ensure the loose washer is lying flat inside of the cone connection

IMPORTANT
Turn on water supply for a few minutes and check all joints and connections for any leaks.

Your tap is now ready to use

6

Please refer to your product's contents page to install the wall bracket.

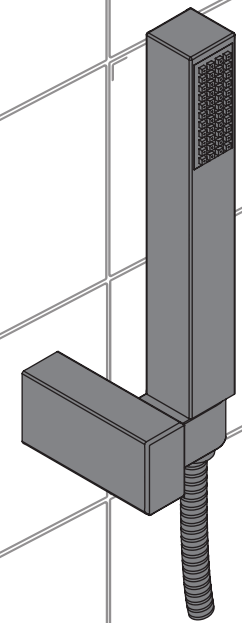

1*

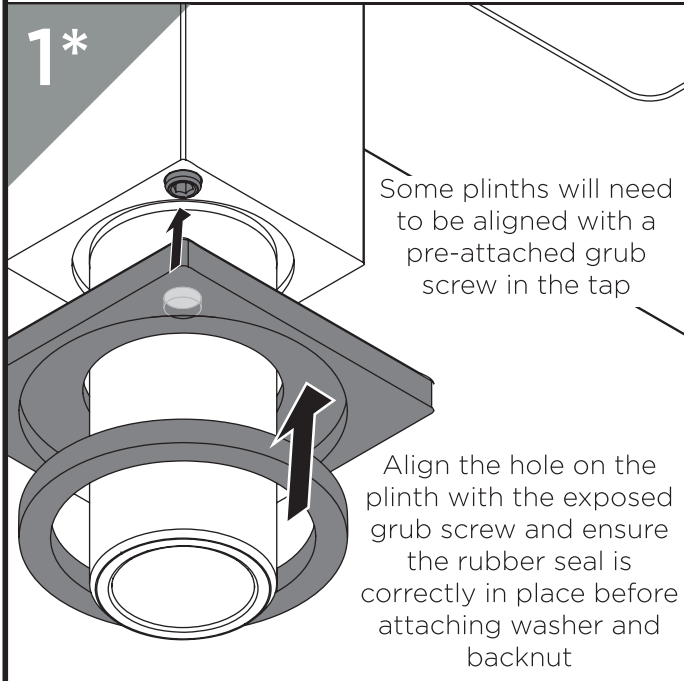

Some plinths will need to be aligned with a pre-attached grub screw in the tap

Align the hole on the plinth with the exposed grub screw and ensure the rubber seal is correctly in place before attaching washer and backnut

2

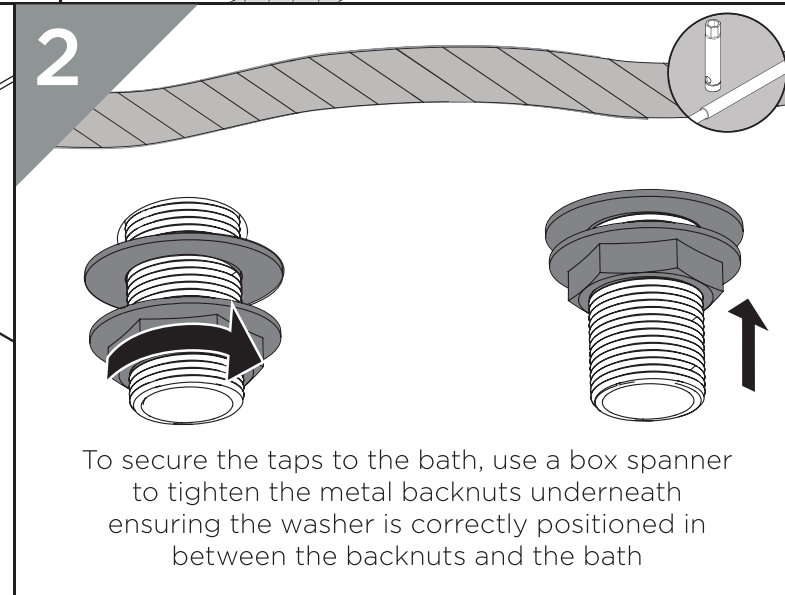

To secure the taps to the bath, use a box spanner to tighten the metal backnuts underneath ensuring the washer is correctly positioned in between the backnuts and the bath

4

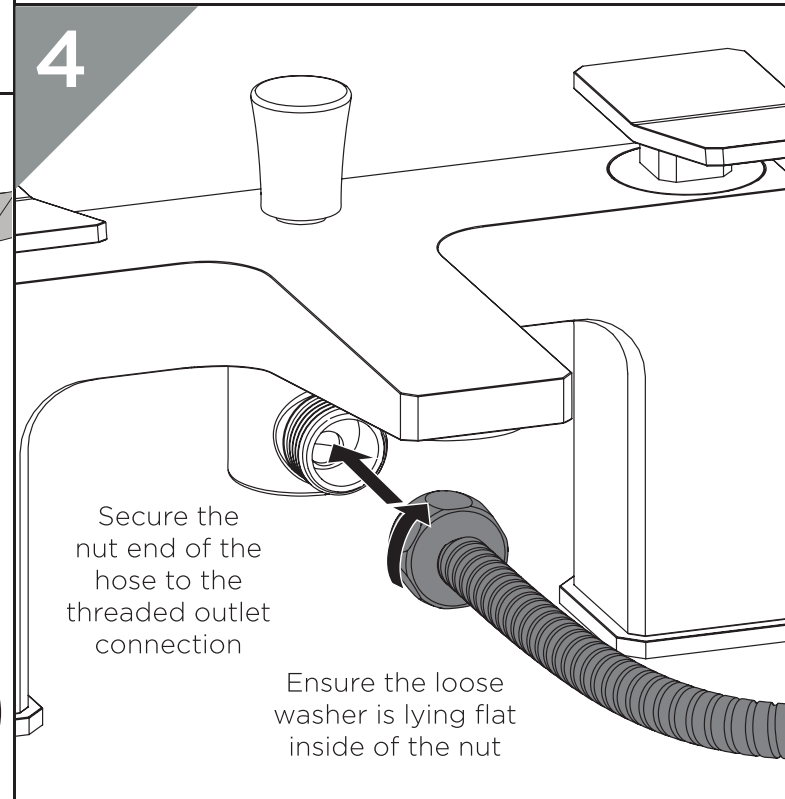

Secure the nut end of the hose to the threaded outlet connection

Ensure the loose washer is lying flat inside of the nut

3

Connect the hot and cold water supplies to the threaded tails

Cold

Hot

REMEMBER
Hot on the left, cold on the right!

General Cleaning

Bristan products are made from premium materials, with hand polished, electroplated, PVD or EPD finishes.

Your taps or shower should be regularly cleaned with warm water, a mild pH-neutral liquid soap, and polished with a soft cloth. Any residues from soap, toothpaste, shampoos and shower gels can cause blemishes if not rinsed off straight after use.

Household bleaches and cleaners contain harsh chemicals and may damage the surface finish. Avoid using abrasive cloths, scouring pads, scrub sponges, steel wool or anything similar.

Maintenance - Valve Replacement

1

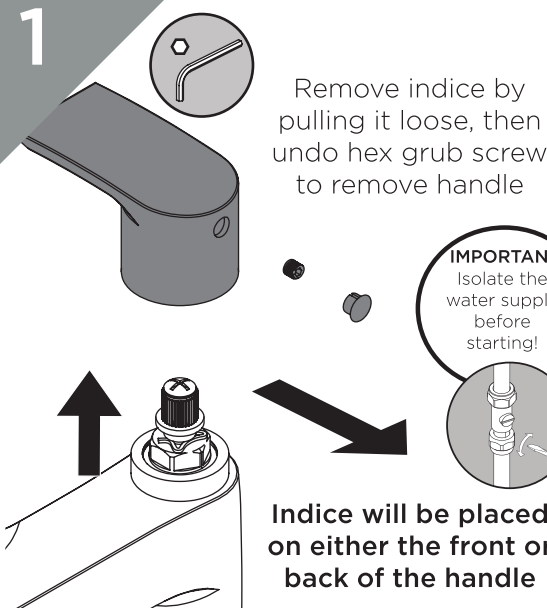

Remove indice by pulling it loose, then undo hex grub screw to remove handle

IMPORTANT
Isolate the water supply before starting!

Indice will be placed on either the front or back of the handle

2

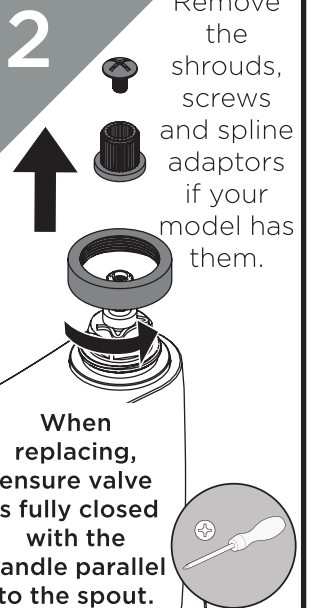

Remove the shrouds, screws and spline adaptors if your model has them.

When replacing, ensure valve is fully closed with the handle parallel to the spout.

3

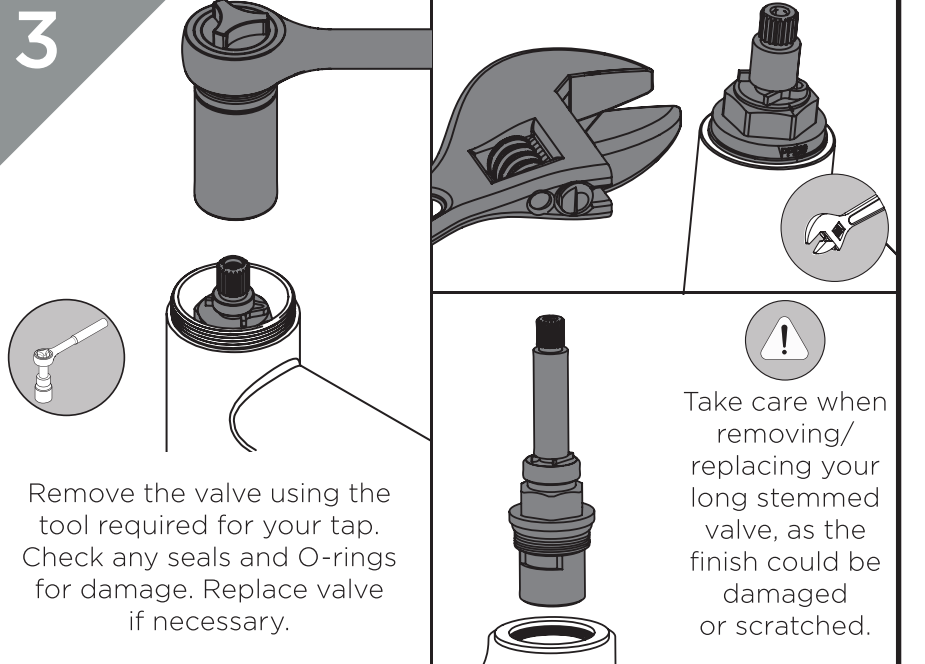

Remove the valve using the tool required for your tap. Check any seals and O-rings for damage. Replace valve if necessary.

Take care when removing/replacing your long stemmed valve, as the finish could be damaged or scratched.

Maintenance - Valve Replacement

4

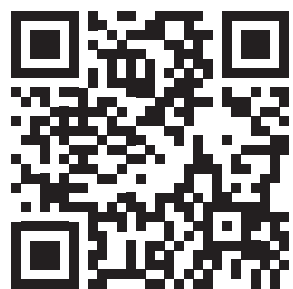

Visit www.bristan.com or scan the QR Code and search for your product code to replace the cartridge for your tap.

5

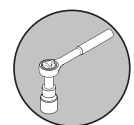
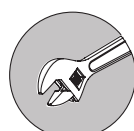

Reverse the steps to replace the valves and handles.



Maintenance - Clean/ Replace Outlet

1a

Housed Outlet

Using an adjustable spanner, unscrew gently to remove the outlet

IMPORTANT
Refer to your contents page to see what outlet your model has

1b

Recessed Outlet

If provided, insert the key tool into the outlet and twist to release it

1c

Coin Slot Outlet

Using a coin, insert into the slot on the outlet and twist to release it

2

Check all loose parts for any damage, then soak using a suitable solution to de-scale

3

Reverse the steps to replace the outlet



Love Your Chrome

Bristan offers an effective chrome-friendly cleaning kit for use with your taps and showers. Scan the QR Code or search for 'CLEAN KIT01' on www.bristan.com.

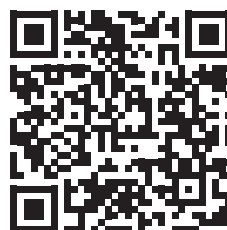

Troubleshooting

Symptom	Cause	Remedy
No flow or low flow rate	Partially closed isolation valve.	Open isolation valve.
	Head of water is below the minimum distance required.	Refer to specification for minimum distance required.
	Hot or cold water being drawn off elsewhere causing pressure changes or instantaneous boiler temperature changes.	Do not use other water outlets when using the taps.
Water dripping from taps	Airlock or partial blockage in the supply pipework.	Flush through pipework to ensure removal of debris and any airlocks.
	This is normal for a short time after using the taps. If water continues to drip, possibly due to the ceramic disc valves	This is caused by residual water tension, the build up of water in the tap body. Remove valves and replace, refer to 'Maintenance' section.
Taps do not turn on	Closed isolation valve.	Open isolation valve.
	Mains water supply turned off.	Turn on mains water supply.
Water not coming from handset when in use	Diverter mechanism not fully open.	Ensure diverter is fully open.
	Kink or blockage in hose	Make sure hose is free of any kinks and free to move. Remove handset and flush through hose.
	Head of water is below the minimum distance required.	Refer to specification for minimum distance required.

Notes

Please use this space for any notes you or your installer may have regarding the installation/plumbing of this product.

Contact Us

BRISTAN

Bristan Group Ltd.

UK: Bristan Group, B78 1SG.
EU: Masco Europe S.à.r.l.
14 Rue Strachen
6933 Mensdorf
Luxembourg

Customer Service: +44330 026 6273
Web: www.bristan.com
Email: enquire@bristan.com

A Masco Company

Our Guarantee

At Bristan, we want to make things as easy as possible for our customers. That's why we offer solid guarantees on all our products, effective from the date of purchase, to give you peace of mind.

To start your free guarantee simply scan the QR code and register your product. Alternatively visit www.bristan.com/register.

For any other queries, please call our Customer Service on 0330 026 6273 where our expert team of advisors will be able to offer you any help and advice.

For full guarantee terms and conditions visit www.bristan.com/service-centre/guarantees.

